

Inquiry  Order

Customer number: \_\_\_\_\_

Company stamp / address:

Contact person: \_\_\_\_\_

Telephone: \_\_\_\_\_

Quotation No.: \_\_\_\_\_

Commission: \_\_\_\_\_

Number of systems: \_\_\_\_\_ Corner angles 90°: \_\_\_\_\_ pieces Number of panels: \_\_\_\_\_

Dimensions: Width: \_\_\_\_\_ (total unfolding) Height: \_\_\_\_\_ (incl. possible floor recession)

Colour:  RAL \_\_\_\_\_  E6-EV1  DB703  DB703FS  Special colour: \_\_\_\_\_  
 Pre anodizing

Glazing:  8 mm toughened glass, clear with Heat-Soak-Test  10 mm toughened glass, clear with Heat-Soak-Test  Special glass: \_\_\_\_\_

Type: (Attention: Inside view, other panel partitions available (max. of 6 panels in one direction possible))

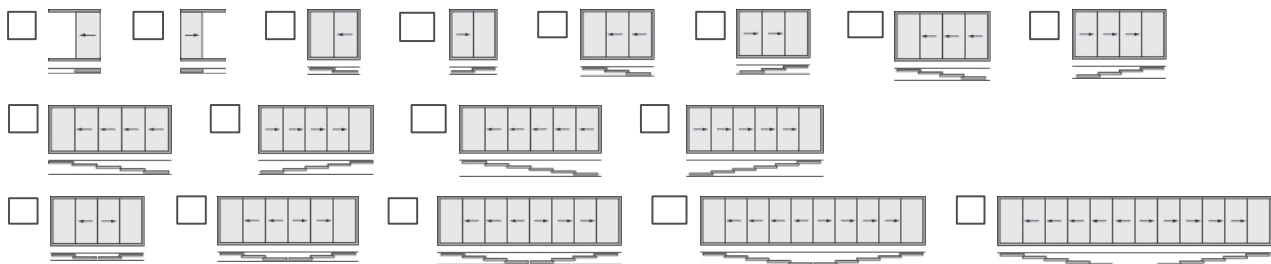

Bottom rail:  with optimally shortened running edges (Standard)  with continuous running edges

Mounting profile (E6-EV1):  without  with (only pos. with att. bottom rail, height incl. mounting pro)  in system color

Rail extension:

right length L \_\_\_\_\_ mm  
 left length L \_\_\_\_\_ mm

Typ:   
 EV1

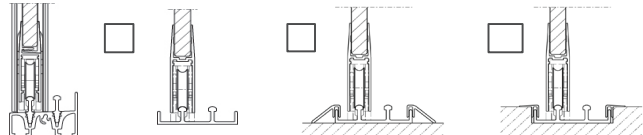

Outdoor use (2-6 tracks)

Indoor use (1-6 tracks)

Lateral wall connection:  without  Lateral frame  Brush gaskets at the panel

Gap gaskets:  Alu E6-EV1  Alu System colour  PVC transparent

Running assembly:  single-sided  double-sided  without

## Handle left:

- 
  \*
   \*
   \*
 Height of knob = \_\_\_\_\_  
 (indicate knob height from lower edge of panel profile)
- \* in system color





## Handle right:

- 
  \*
   \*
   \*
 Height of knob = \_\_\_\_\_  
 (indicate knob height from lower edge of panel profile)
- \* in system color

## Handle center:

- 
  \*
   \*
   \*
 Height of knob = \_\_\_\_\_  
 (indicate knob height from lower edge of panel profile)
- left     right
- \* in system color

## Locking left: (only with vertical frame!)

- 
 
 
 Height locking = \_\_\_\_\_ (indicate knob height from lower edge of panel profile)
- with two-sided profile cylinder, keyed alike
- 
 with lock
- 
 with two-sided profile cylinder
- 
 with two-sided profile cylinder, keyed alike
- inside     outside

## Locking right: (only with vertical frame!)

- 
 
 
 Height locking = \_\_\_\_\_ (indicate knob height from lower edge of panel profile)
- with two-sided profile cylinder, keyed alike
- 
 with lock
- 
 with two-sided profile cylinder
- 
 with two-sided profile cylinder, keyed alike
- inside     outside

## Locking center:

- 
 
 
 Height locking = \_\_\_\_\_ (indicate knob height from lower edge of panel profile)
- with two-sided profile cylinder, keyed alike and counter box
- 
 with lock
- 
 with two-sided profile cylinder and counter box
- 
 with two-sided profile cylinder, keyed alike and counter box
- inside     outside

Please enclose floor plan resp. view sketch and remarks (please use inside view)